



NiMH
Rechargeable
Batteries



NiMH

Rechargeable Batteries



Committed to continued efforts in R&D and product innovation, GP Batteries is proud to present a whole new range of high capacity NiMH batteries. This has been achieved through revolutionary designs in construction and new chemical formulation that increase the utilisation efficiency of the electrodes. The performance has also been perfected by the cell's improved mechanical construction and the use of unique thinner and stronger separators.

Major Features

High capacity

GP NiMH batteries have high energy density and deliver up to double the capacity of NiCd batteries of similar size. They are most suitable for sophisticated high drain applications e.g. video cameras, cellular phones, notebook computers, etc.

Superior high rate discharge characteristics

Up to 3C high rate discharge is possible.

Broad operating temperature range

-20°C to 60°C.

Quick charging capability

Rapid charge in about one hour with GP specified charging condition.

Long service life

Under different usage conditions, GP NiMH batteries can deliver 300 -1000 charge/discharge cycles.

Excellent overcharge endurance

GP NiMH batteries can be continuously charged at 0.1C rate for one year without leakage or deformation.

Built-in safety protection mechanism against misuse

A resealable safety vent is built in to relieve internal pressure in case of misuse. Polarity reversal and overdischarge protection mechanisms are also incorporated in the cell.

Absolutely no memory effect

Discharge is not required before charging.

Environmentally friendlier

No cadmium, lead or mercury are added. Most suitable for markets with high environmental concerns.

Comprehensive range

GP NiMH batteries comprise of a comprehensive range of different cylindrical and prismatic sizes catering for a wide range of applications.

High reliability

GP NiMH batteries are produced with the best available material and advanced technology, allowing them to perform with outstanding reliability.

ISO 9001 accreditation

Sylva Industries Ltd., the manufacturing arm of GP Batteries received ISO 9001 accreditation in the design and manufacture of secondary and primary batteries in 1996.



Cell Construction

Cylindrical

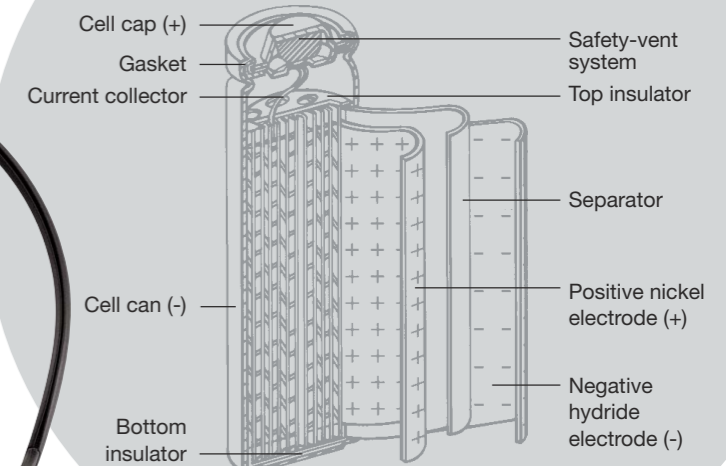

Major Applications

Communications

Cellular phones, cordless phones, transceivers.

Information devices

Notebook computers, personal digital assistants (PDAs), portable facsimile machines.

Audio and video devices

Digital video cameras, LCD TVs, portable DVD, VCD, MD and CD players.

Emergency lighting

Remote controls & security systems

Other applications

Remote control toys, shavers, massagers, electric tooth brushes, handheld vacuum cleaners, power tools, handheld terminals, electric bicycles, etc.

Prismatic

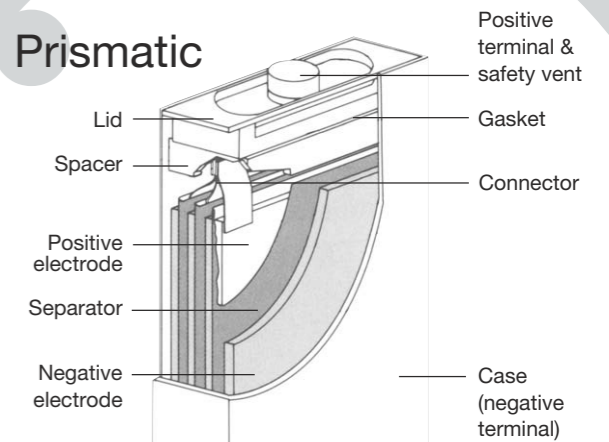

9V

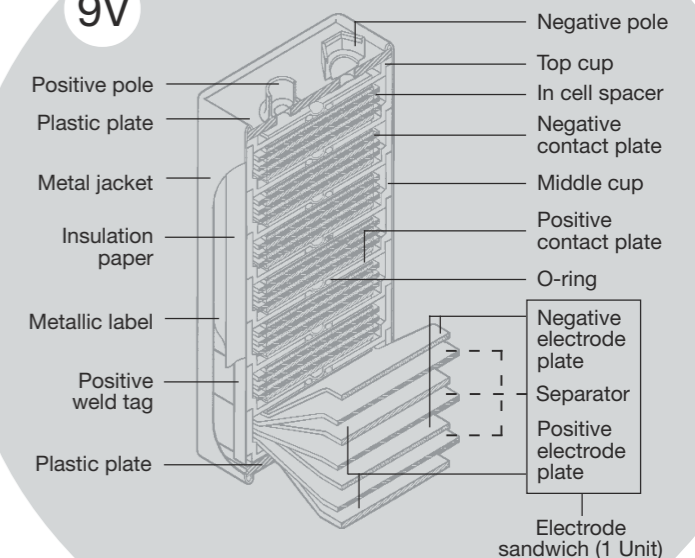

Specifications

High Capacity Series

Cell Size	Model No.	Nominal Voltage (V)	Capacity (0.2C discharge)* (mAh)		Nominal Dimension (mm)		Weight (g)	Standard Charge		1 Hr Charge Current (mA)#	
			Minimum	Typical	Diameter	Height		Current (mA)	Time (hour)		
AAA	2/3 AAA	GP40AAAM	1.2	400	428	10.2	29.2	7.7	40	16	400
	4/5 AAA	GP50AAASH	1.2	500	515	10.4	36.3	9.3	50	16	500
	AAA	GP65AAAH	1.2	650	680	10.5	43.7	13	65	16	650
	AAA	GP70AAAH	1.2	700	730	10.5	43.7	13	70	16	700
	AAA	GP75AAAH	1.2	750	780	10.5	43.7	13	75	16	750
	AAA	GP80AAAH	1.2	780	800	10.5	43.7	14	80	16	800
	AAAL	GP85AALH	1.2	850	880	10.5	50	15	85	16	850
	7/5 AAAL	GP100AALH	1.2	1000	1050	10.5	66.5	19.5	100	16	1000
	9/5 AAAL	GP120AALH	1.2	1200	1250	10.5	80	23	120	16	1200
AA	2/3 AA	GP75AAH	1.2	750	770	14.5	28.7	15	75	16	750
	AA	GP150AAM**	1.2	1500	1530	14.4	48.2	26	150	16	1500
	AA	GP160AAH**	1.2	1600	1640	14.5	49.2	26	160	16	1600
	AA	GP170AAH	1.2	1700	1750	14.5	49.2	27	170	16	1700
	AA	GP180AAH	1.2	1800	1850	14.5	49.2	27	180	16	1800
	7/5 AA	GP190AAH	1.2	1900	1960	14.5	65	35	190	16	1900
AF	4/5 AF	GP211AFH	1.2	2100	2160	17	43	32	210	16	2100
	AF	GP250AFH**	1.2	2500	2550	17	50.2	39	250	16	2500
	AF	GP270AFH	1.2	2600	2700	17	50.2	39.5	270	16	2700
	7/5 AF	GP370AFM	1.2	3700	3750	17.2	67	52	370	16	3700
	7/5 AF	GP380AFH**	1.2	3700	3800	17.5	67	53.5	380	16	3800
	N	GP50NH	1.2	500	520	11.65	29.4	9.8	50	16	500
18650	18650	GP410LAH	1.2	4100	4220	18.3	65.5	58	410	16	4100
18670	18670	GP450LAH**	1.2	4300	4500	18.3	67	60	450	16	4500
Sub-C	4/5 Sub-C	GP200SCH	1.2	2000	2100	23	34	48	200	16	2000
	Sub-C	GP300SCH	1.2	3000	3150	23	43	61	300	16	3000
	Sub-C	GP300SCHR	1.2	2800	3000	23	43	61	300	16	3000
	Sub-C	GP330SCH	1.2	3100	3300	23	44.5	62	330	16	3300
	Sub-C	GP330SCHR	1.2	3100	3300	23	44.5	62	330	16	3300
C	C	GP350CH	1.2	3500	3850	25.8	50	78.5	350	16	3500
	D	GP700DH**	1.2	7000	7350	33	60	155	700	16	7000
F	D	GP900DH**	1.2	9000	9225	33	60	170	900	16	Not Applicable
	F	GP1300FH	1.2	13000	13650	33	90	247	1300	16	Not Applicable

Typical Ambient Temperature : Standard Charge: 0°C to 45°C / Fast Charge: 10°C to 45°C / Discharge: -20°C to 50°C / Storage: -20°C to 35°C

High Temperature Series

AAA	AAA	GP60AAAH	1.2	600	630	10.5	43.7	13	60	16	Not Applicable
AA	AA	GP125AAM**	1.2	1250	1280	14.4	48.2	26	125	16	Not Applicable
AF	4/5 AF	GP160AFHT	1.2	1600	1680	17	43	33	160	16	Not Applicable
	AF	GP210AFHT	1.2	2100	2205	17	50	38	210	16	Not Applicable
18700	18700	GP400LAHT	1.2	4000	4200	18.3	70	66	400	16	Not Applicable
Sub-C	Sub-C	GP220SCHT**	1.2	2200	2420	23	43	53	220	16	Not Applicable

Typical Ambient Temperature : Charge: 0°C to 70°C / Discharge: -20°C to 70°C / Storage: -20°C to 35°C

High Drain Series

AA	AA	GP130AAHE	1.2	1300	1350	14.5	49.2	25.5	130	16	1300
----	----	-----------	-----	------	------	------	------	------	-----	----	------

Typical Ambient Temperature : Standard Charge: 0°C to 45°C / Fast Charge: 10°C to 45°C / Discharge: -20°C to 50°C / Storage: -20°C to 35°C

One hour rate with charge termination control. * After charging at 0.1 C for 16 hours. ** With UL approval.

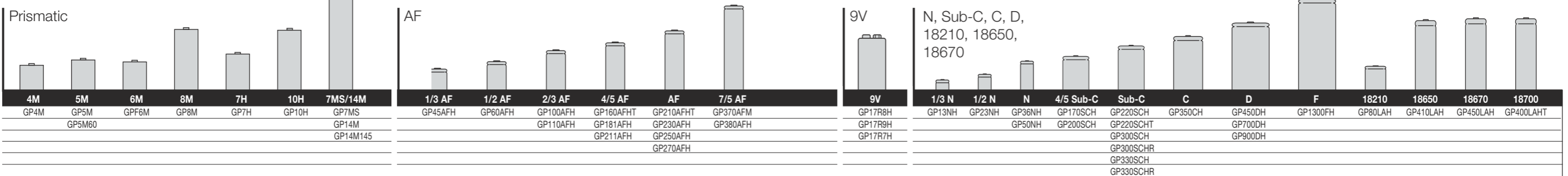
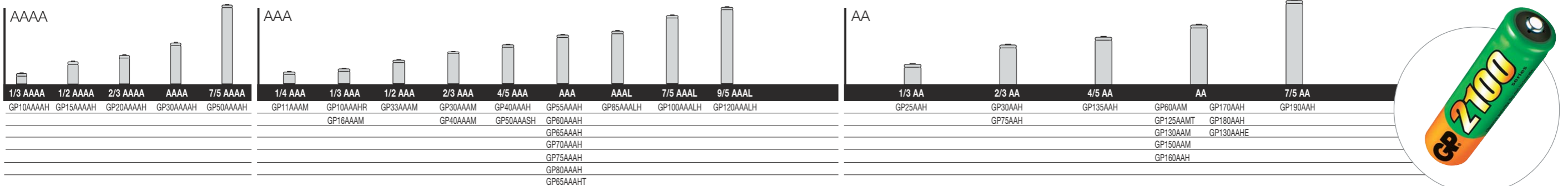

Standard Series

Cell Size	Model No.	Nominal Voltage (V)	Capacity (0.2C discharge)* (mAh)		Nominal Dimension (mm)		Weight (g)	Standard Charge		1 Hr Charge Current (mA)#	
			Minimum	Typical	Diameter	Height		Current (mA)	Time (hour)		
AAAA	1/3 AAAA	GP10AAAAH	1.2	100	105	8.6	15.4	2.6	10	16	100
	1/2 AAAA	GP15AAAAH	1.2	150	168	8.6	20.5	3.5	15	16	150
	2/3 AAAA	GP20AAAAH	1.2	200	210	8.6	29.5	4.7	20	16	200
	AAAA	GP30AAAAH	1.2	300	320	8.4	40.6	6.5	30	16	300
	7/5 AAAA	GP50AAAAH	1.2	500	520	8.4	66	10.5	50	16	500
AAA	1/4 AAA	GP11AAAM	1.2	110	115	10.2	10.7	2.8	11	16	110
	1/3 AAA	GP10AAAH	1.2	100	110	10.4	15.6	3.9	10	16	100
	1/3 AAA	GP16AAAM	1.2	160	168	10.2	14.6	3.75	16	16	160
	1/2 AAA	GP33AAAH	1.2	315	330	10.15	22.4	6	33	16	330
	2/3 AAA	GP30AAM	1.2	300	315	10.2	29.2	7.2	30	16	300
	4/5 AAA	GP40AAAH	1.2	400	450	10.4	36.3	8.5	40	16	400
	AAA	GP55AAAH	1.2	550	578	10.5	43.7	13	55	16	550
	AAA	GP60AAAH	1.2	600	630	10.5	43.7	13	60	16	600
	1/3 AA	GP25AAH	1.2	250	270	14.5	16.6	7	25	16	250
AA	2/3 AA	GP30AAH	1.2	300	320	14.5	28.7	10	30	16	300
	4/5 AA	GP135AAH	1.2	1350	1400	14.5	42.5	22.8	135	16	1350
	AA	GP60AAM	1.2	600	630	14.4	48.2	15	60	16	600
	AA	GP130AAM**	1.2	1300	1340	14.4	48.2	25	130	16	1300
	1/3 AF	GP45AFH	1.2	450	500	17	16.3	10	45	16	450
AF	1/2 AF	GP60AFH	1.2	600	650	17	22	14	60	16	600
	2/3 AF	GP100AFH	1.2	1000	1080	17	28.7	22	100	16	1000
	2/3 AF	GP110AFH	1.2	1100	1133	17	28.5	21	110	16	1100
	4/5 AF	GP181AFH	1.2	1800	1860	17	43	32	180	16	1800
	AF	GP230AFH	1.2	2300	2350	17	50.2	36	230	16	2300
	1/3 N	GP13NH	1.2	130	137	11.65	12.4	3.85	13	16	130
N	1/2 N	GP23NH	1.2	230	241	11.65	17	6.2	23	16	230
	N	GP36NH	1.2	360	380	11.65	29.4	8.6	36	16	360
	18210	18210	GP80LAH	1.2	800	860	18.3	21.5	17	80	16
Sub-C	4/5 Sub-C	GP170SCH	1.2	1700	1870	23	34	46	170	16	1700
	Sub-C	GP220SCH**	1.2	2200	2420	23	43	55	220	16	2200
D	D	GP450DH	1.2	4500	4725	33	60	130	450	16	Not Applicable

Typical Ambient Temperature : Standard Charge: 0°C to 45°C / Fast Charge: 10°C to 45°C / Discharge: -20°C to 50°C / Storage: -20°C to 35°C

Prismatic Series

Prismatic	Prismatic	GP4M	1.2	400	440	6.1(T) x 17.0(W) x 31.3(H)	10	40	16	400
	Prismatic	GP5M	1.2	500	550	6.1(T) x 17.0(W) x 35.3(H)	12	50	16	500
	Prismatic	GP5M60	1.2	550	600	6.1(T) x 17.0(W) x 35.3(H)	11	55	16	550
	Prismatic	GP6M	1.2	550	600	6.7(T) x 16.1(W) x 33.8(H)	11	55	16	550
	Prismatic	GP7H	1.2	720	780	8.3(T) x 17.0(W) x 35.3(H)	15	72	16	720
	Prismatic	GP7MS	1.2	700	750	6.1(T) x 17.0(W) x 67.0(H)	17	70	16	700
	Prismatic	GP8M	1.2	800	850	6.1(T) x 17.0(W) x 48.0(H)	17	80	16	800
	Prismatic	GP10H	1.2	1000	1100	8.3(T) x 17.0(W) x 48.0(H)	22	100	16	1000
	Prismatic	GP14M**	1.2	1250	1400	6.1(T) x 17.0(W) x 67.0(H)	23	125	16	1250
	Prismatic									

NIMH

Rechargeable Batteries



Performance Characteristics

Cylindrical Cells

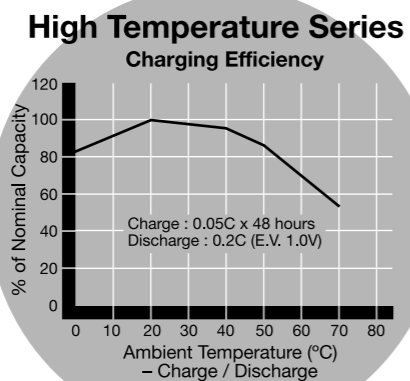
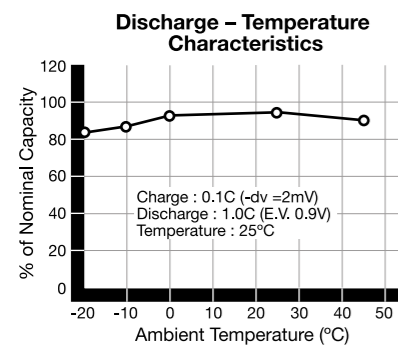
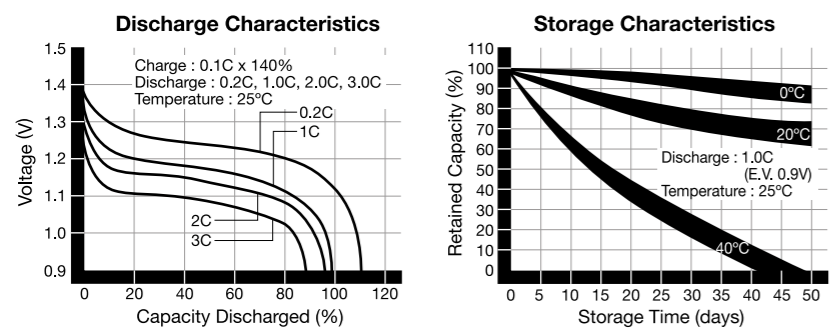
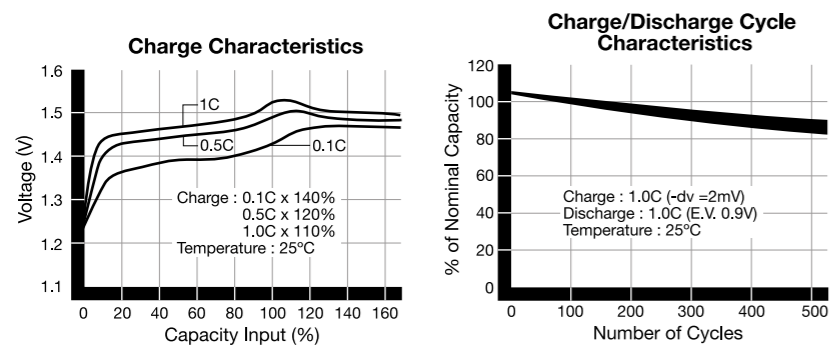

Prismatic Cells

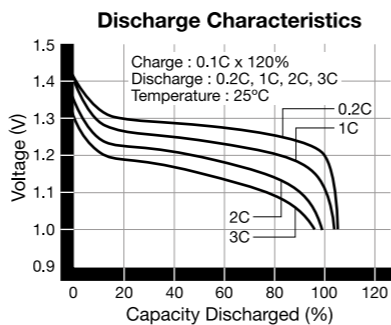
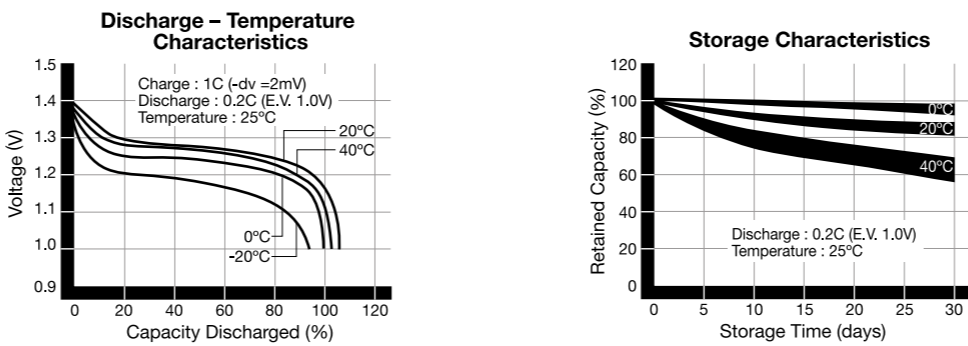
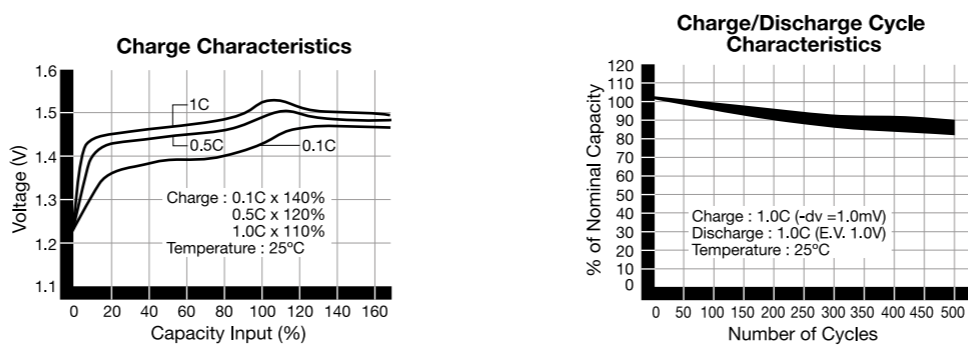

9V Batteries

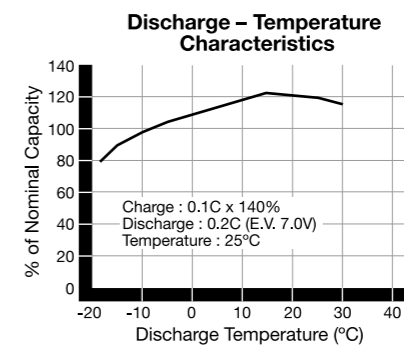
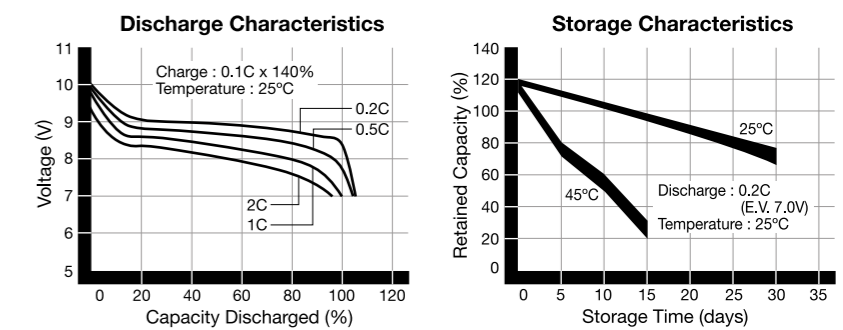
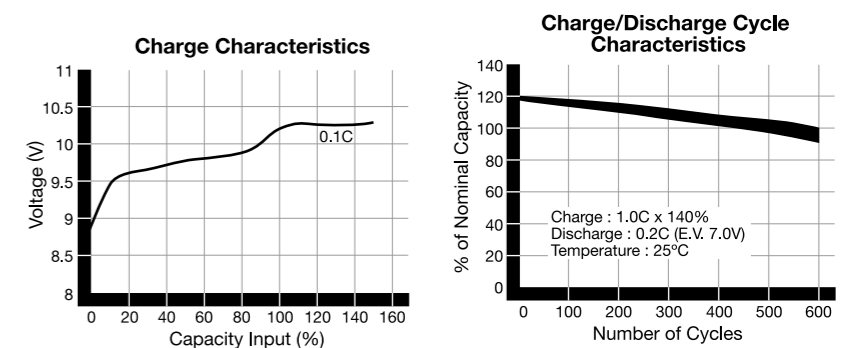

Battery Handling and Precautions

Soldering

Do not solder directly onto batteries. Always solder onto solder tag for connection.

Charging and Discharging

Always charge batteries before first time application. Parallel charging or connection is not recommended. Parallel charging will produce irregular charging currents. Please consult GP Batteries for more details. Never short-circuit or reverse polarity in application. Do not use different types of batteries in the same battery assembly. If the battery has been deep-discharged, a prolonged charging time is required to bring the battery back to full capacity.

Storage

Always store batteries in a cool, dry place. After long storage, e.g. over a year, it is desirable to cycle (charge/discharge) the battery 3 times to restore full capacity. Do not mix batteries with metal objects during storage or transportation to avoid accidental short-circuit. Do not store large quantities of batteries in a densely packed condition when they are in a charged or partially charged state.

Battery Handling

Do not incinerate or dismantle batteries. Cell components are corrosive and may be harmful to skin and eyes. Do not pull on battery lead wires or connector. Excessive force on the leads or connectors can damage the welding joints or other connections.

Easy Battery Removal

Some countries have legislation requiring easy removal of batteries from the devices. When designing a product, consideration should be given to the use of a socket connector and an easy-to-open battery compartment.

GP Batteries

WORLDWIDE HEADQUARTERS

Hong Kong

GPI International Limited

8/F., Gold Peak Building, 30 Kwai Wing Road, Kwai Chung, N.T., Hong Kong
Tel : (852) 2484 3333 Fax : (852) 2480 5912
E-mail address : gp@goldpeak.com Website : www.gpbatteries.com.hk

SALES AND MARKETING BRANCH OFFICES

ASEAN

GP BATTERY MARKETING (SINGAPORE) PTE. LIMITED
97 Pioneer Road, Singapore 639579
Tel: (65) 6863 1534 Fax: (65) 6863 8669

MALAYSIA

GP BATTERY MARKETING (MALAYSIA) SDN. BHD.
Lot 8, Jalan Pemberita U1/49, Temasya Industrial Park,
40150 Shah Alam, Selangor Darul Ehsan, Malaysia
Tel: (60) 3 5569 3499 Fax: (60) 3 5569 3498

THAILAND

GP BATTERY MARKETING (THAILAND) CO., LIMITED
3/F., V.H. Commercial Building, 23/1 Soi Ngamwongwan 9,
Ngamwongwan Road, Bangkok, Muang,
Nonthaburi 11000, Thailand
Tel: (66) 2 952 5323/4/5 Fax: (66) 2 952 5322

TAIWAN

GP BATTERY MARKETING (TAIWAN) LIMITED
Room 1200, International Trade Building, No.205 Sec.1,
Tun Hua South Road, Taipei 10647, Taiwan R.O.C.
Tel: (886) 2 2741 4919 Fax: (886) 2 2731 4868

CHINA

HUIZHOU CHAO BA BATTERY TECHNOLOGY CO., LTD.
2/F., South of Hongye Industrial Building,
Tianluo Mountain, 14th Industrial District, Huizhou City,
Guangdong, China (Postal Code: 516003)
Tel: (86) 752 282 8428 Fax: (86) 752 280 2872

HONG KONG

GP BATTERY MARKETING (H.K.) LIMITED
8/F, Gold Peak Building, 30 Kwai Wing Road,
Kwai Chung, N.T., Hong Kong
Tel: (852) 2420 0281 Fax: (852) 2494 9349

KOREA

SmartPower corp.
Tel. (82)2-573-9288
Fax. (82)2-573-9690

U.S.A.

GOLD PEAK INDUSTRIES (NORTH AMERICA) INC.
11235 West Bernardo Court, San Diego,
CA 92127-1638, U.S.A.
Tel: (1) 858 674 6099 Fax: (1) 858 674 6496

CANADA

GP BATTERY MARKETING INC.
Unit 7, 7780 Woodbine Avenue, Markham,
Ontario, Canada L3R 2N7
Tel: (1) 905 474 9507 Fax: (1) 905 474 9452

LATIN AMERICA

GP BATTERY MARKETING (LATIN AMERICA) INC.
8370 NW, 66TH Street, Miami, Florida 33166, U.S.A.
Tel: (1) 305 471 7717 Fax: (1) 305 471 7718

EUROPE

GP BATTERY MARKETING (EUROPE) S.A.
75 Zae Du Trou Grillon,
91280 St Pierre Du Perray, Paris, France
Tel: (33) 1 6989 6200 Fax: (33) 1 6989 6221

GERMANY

GP BATTERY MARKETING (GERMANY) GMBH
Niederförricker Str. 62, D-40667 Meerbusch, Germany
Tel: (49) 2132 971504/5/6 Fax: (49) 2132 80145

POLAND

GP BATTERY (POLAND) SPÓŁKA Z O.O.
ul. Słowicza 19, 02-170 Warszawa, Poland
Tel: (48) 22 868 0490 Fax: (48) 22 846 7535

U.K.

GP BATTERIES (U.K.) LIMITED
Summerfield Avenue, Chelston Business Park,
Wellington, Somerset, TA21 9JF, U.K.
Tel: (44) 1 823 660 044 Fax: (44) 1 823 665 595

ITALY

GP BATTERY MARKETING ITALY S.R.L.
Via A. Volta, 3 Assago - MI - Italy
Tel: (39) 02 488 2512 Fax: (39) 02 488 2865

SCANDINAVIA

GPBM NORDIC AB
Grimboönsen 5, 417 49 Gothenburg, Sweden
Tel: (46) 31 558 600 Fax: (46) 31 556 813

Distributed by:

GPPIA10CH-A 08/03 All rights reserved. No parts of this catalogue written or pictorial may be reproduced without the express consent of GP Batteries.